

# WEST L.A. OFFICE/FLEX BUILDING FOR SALE

2320 Cotner Avenue | Los Angeles, CA

OFFERING MEMORANDUM

GREAT OWNER-USER OPPORTUNITY



# West L.A. Office/Flex Building For Sale

## CONTENTS

### 01 Executive Summary

Investment Summary

### 02 Location

Location Summary

Aerial Map

Drive Times (Heat Map)

Drive Times

### 03 Property Description

Floor Plan

Site Plan

Property Images

### 04 Demographics

Demographics

*Exclusively Marketed by:*

**JUSTIN ALTEMUS**

THE ALTEMUS COMPANY

The Altemus Company

(310) 478-7729

JUSTIN@ALTEMUSCOMPANY.COM

Lic: 01271444



01 Executive Summary  
Investment Summary

---

## OFFERING SUMMARY

---

ADDRESS	2320 Cotner Avenue Los Angeles CA 90064
BUILDING SF	5,350 SF
PARKING RATIO	1.87/1,000 SF
LAND SF	6,540 SF
ZONING	LA-M2

---

## FINANCIAL SUMMARY

---

PRICE	\$3,725,000
PRICE PSF	\$696.26

---

## PROPERTY HIGHLIGHTS

- ⇒ Ground Floor comprised of approximately 4,150 square feet with 2,775 square feet of office and 1,375 square feet of warehouse/storage. Also includes a double pedestrian door entry into the warehouse area.
- ⇒ Second Floor is **self contained** and comprised of approximately 1,200 square feet of office space with a private roof deck.
- ⇒ Ample Parking on the premises. 10 car parking (5 tandem parking spaces). **Additional parking** available in the area.
- ⇒ Perfect for a variety of office, studio, flex and other commercial uses. **Great owner-user or partial owner-user opportunity.**
- ⇒ Combination of private offices and open area to meet various layout needs (See attached floor plans)
- ⇒ Possession upon close of escrow. Seller may consider leasing back the second floor offices (Approximately 1,200 sf) at close of escrow to provide additional cash flow and growth opportunity for Buyer. Lease term is negotiable
- ⇒ Building is occupied. To show, please call broker.

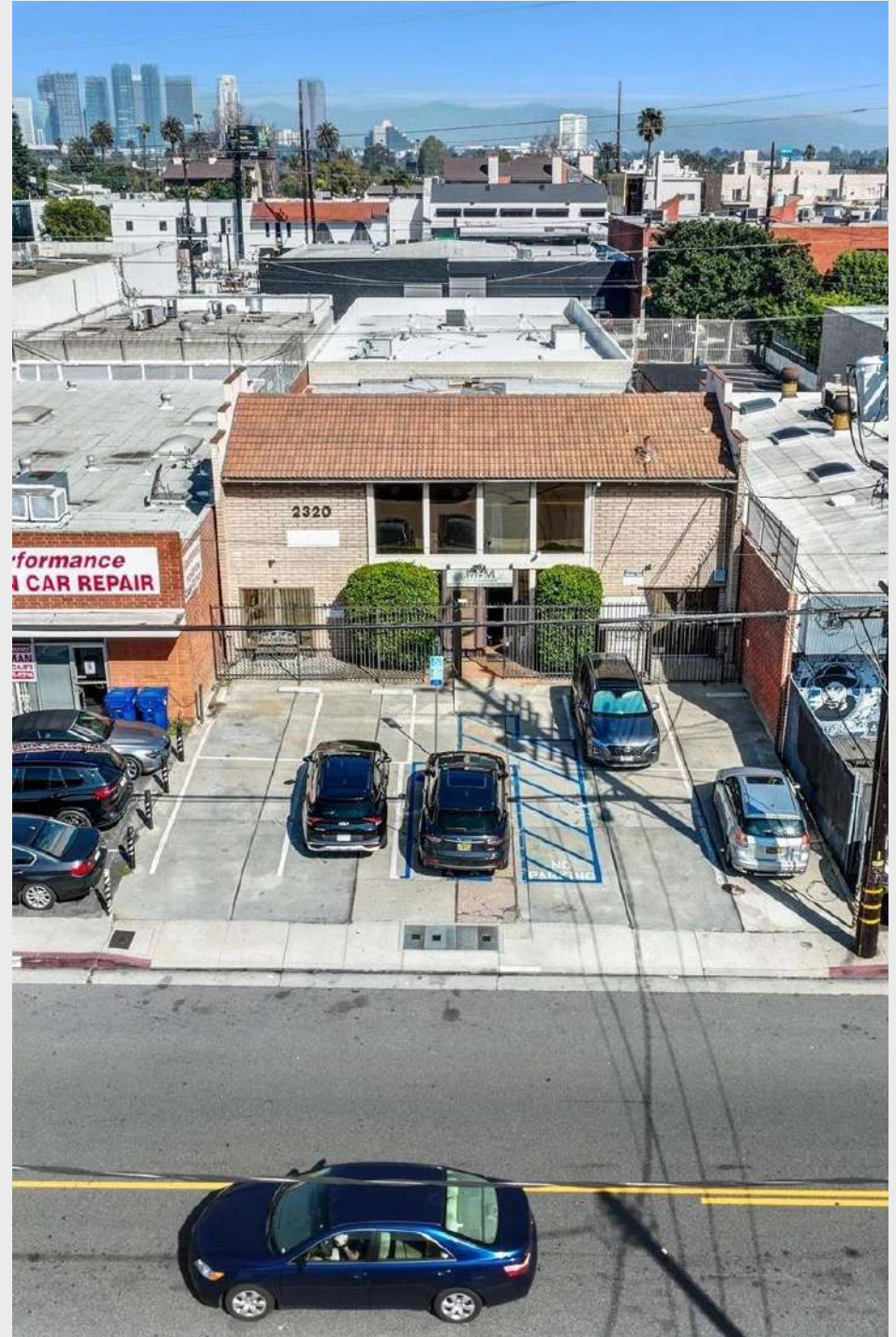

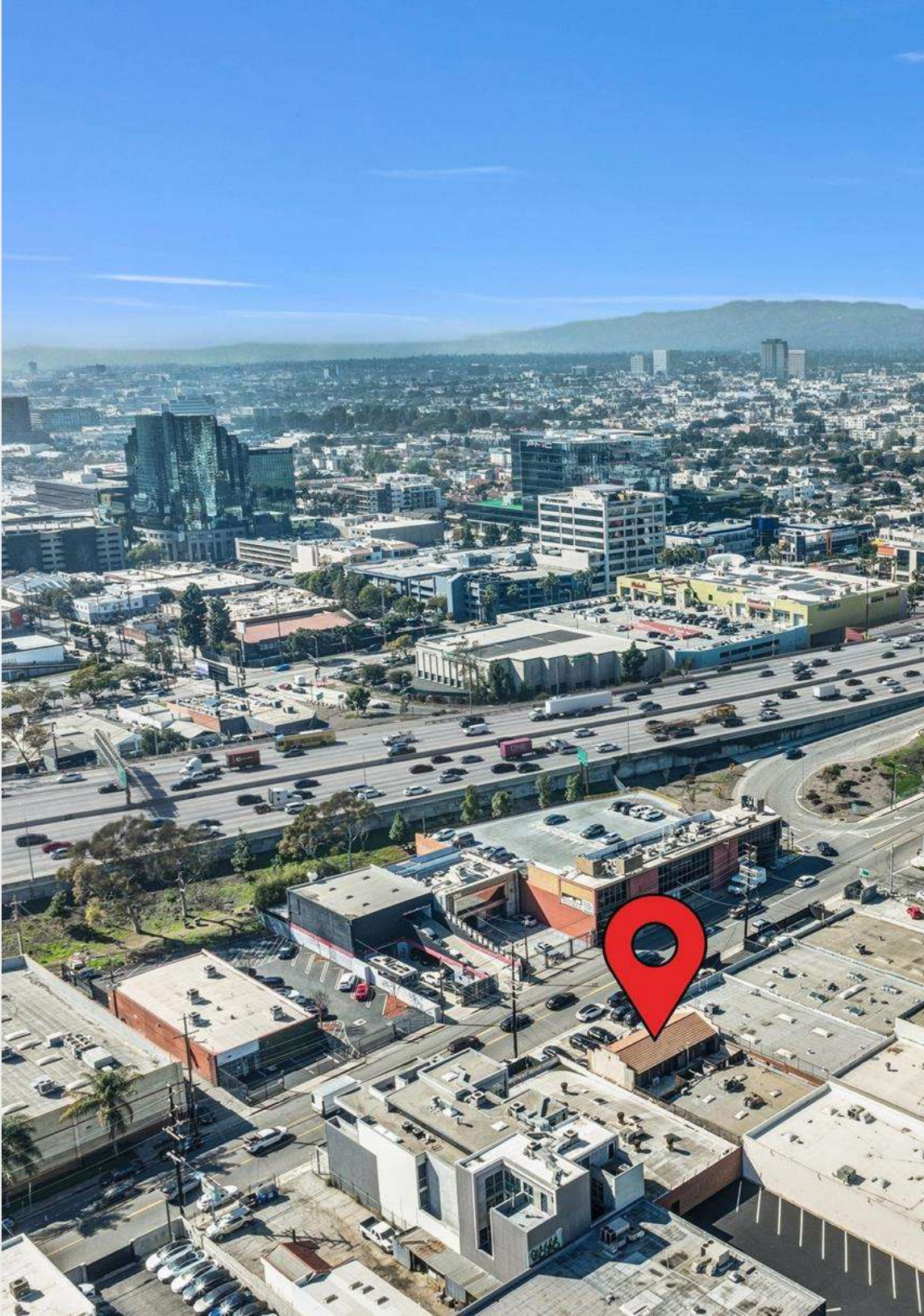

02

Location

Location Summary

Aerial Map

Drive Times (Heat Map)

Drive Times

⇒ Great central, West LA location within close proximity to the 405/10 Freeways, Sawtelle Retail Corridor and the Expo Rail Line.

⇒ The property is located in the West Los Angeles neighborhood, known for its affluent residents and upscale retail and amenities.

⇒ Nearby attractions include the Century City Mall which offers a variety of retail stores and restaurants.

⇒ The property is in close proximity to UCLA, a prestigious university known for its research and academic programs.

⇒ The neighborhood features a mix of residential and commercial properties, providing a diverse and vibrant community.

⇒ Major thoroughfares such as Santa Monica Boulevard and the I-405 freeway offer convenient access to other parts of Los Angeles.

## Regional Map

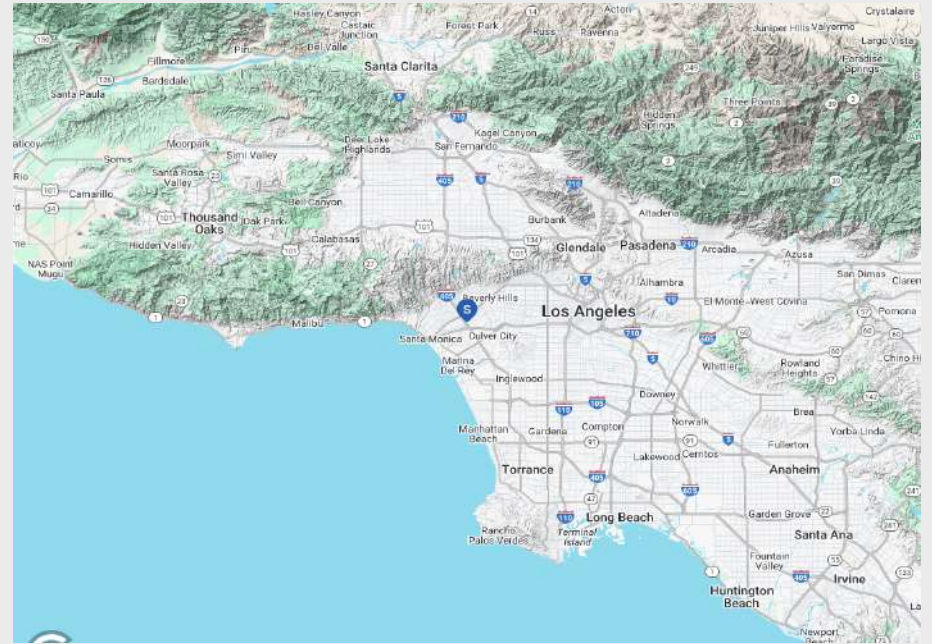

## Local Map

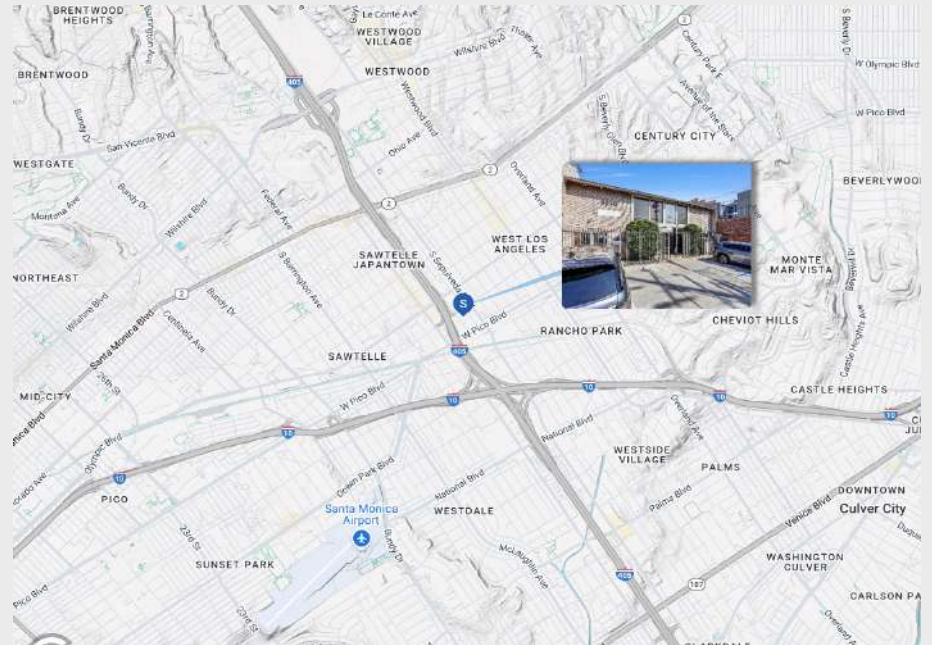



**2320 COTNER AVE**  
LOS ANGELES, CA

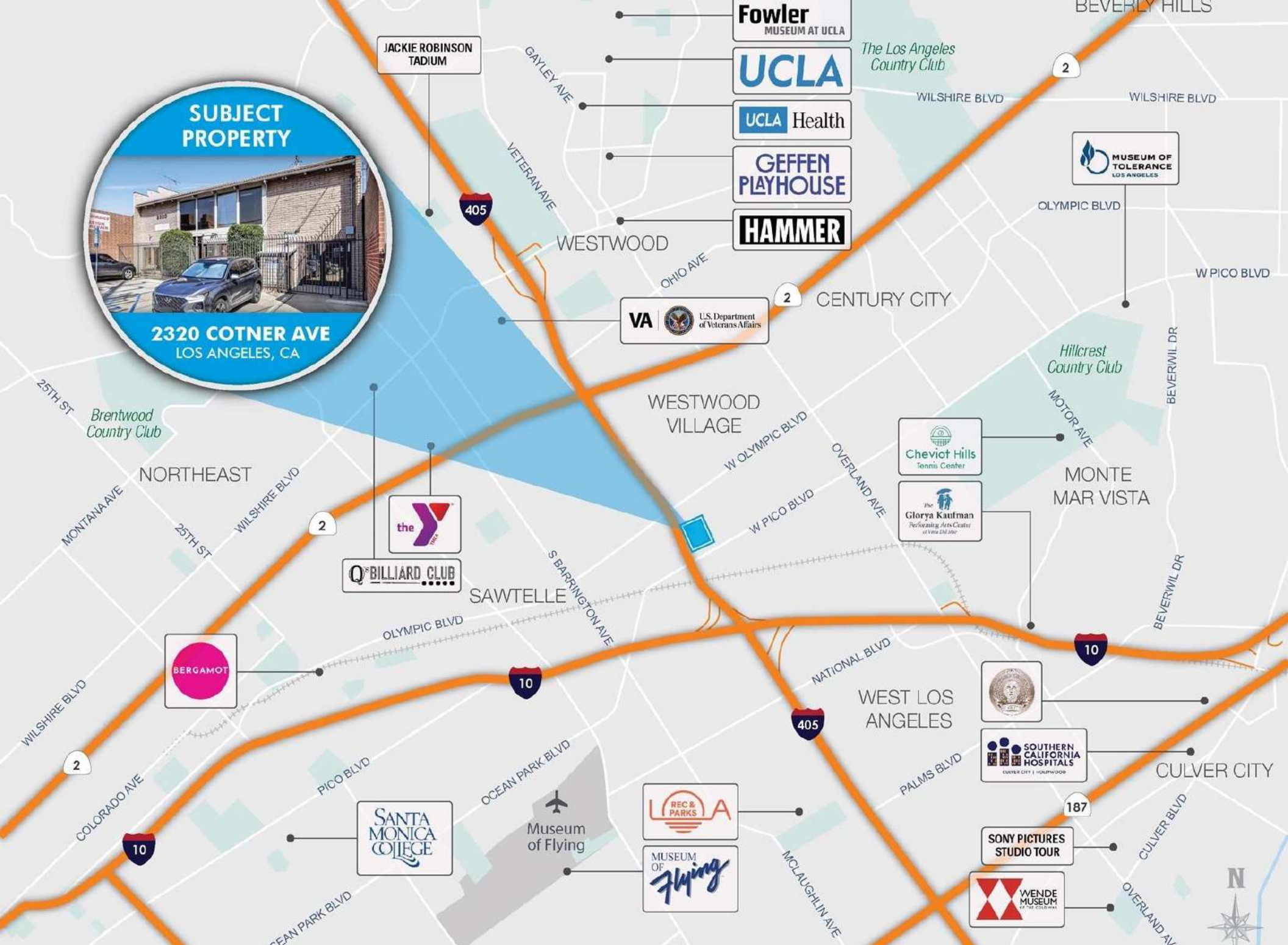

JACKIE ROBINSON  
STADIUM

**Fowler**  
MUSEUM AT UCLA

**UCLA**

**UCLA Health**

**GEFFEN  
PLAYHOUSE**

**HAMMER**

*The Los Angeles  
Country Club*

**MUSEUM OF  
TOLERANCE  
LOS ANGELES**

**VA** U.S. Department  
of Veterans Affairs

2 CENTURY CITY

*Hillcrest  
Country Club*

*Brentwood  
Country Club*

NORTHEAST

**the Y**

**Q BILLIARD CLUB**

SAWTELLE

**BERGAMOT**

**Cheviot Hills  
Tennis Center**

**The Gloria Kaufman  
Performing Arts Center  
at Vana and Mar**

MONTE  
MAR VISTA

**SOUTHERN  
CALIFORNIA  
HOSPITALS**

**SOUTHERN  
CALIFORNIA  
HOSPITALS**

**SANTA MONICA  
COLLEGE**

Museum  
of Flying

**LA  
REC & PARKS**

**MUSEUM  
OF  
Flying**

WEST LOS  
ANGELES

**SONY PICTURES  
STUDIO TOUR**

**WENDE  
MUSEUM  
OF THE COLLEGE**

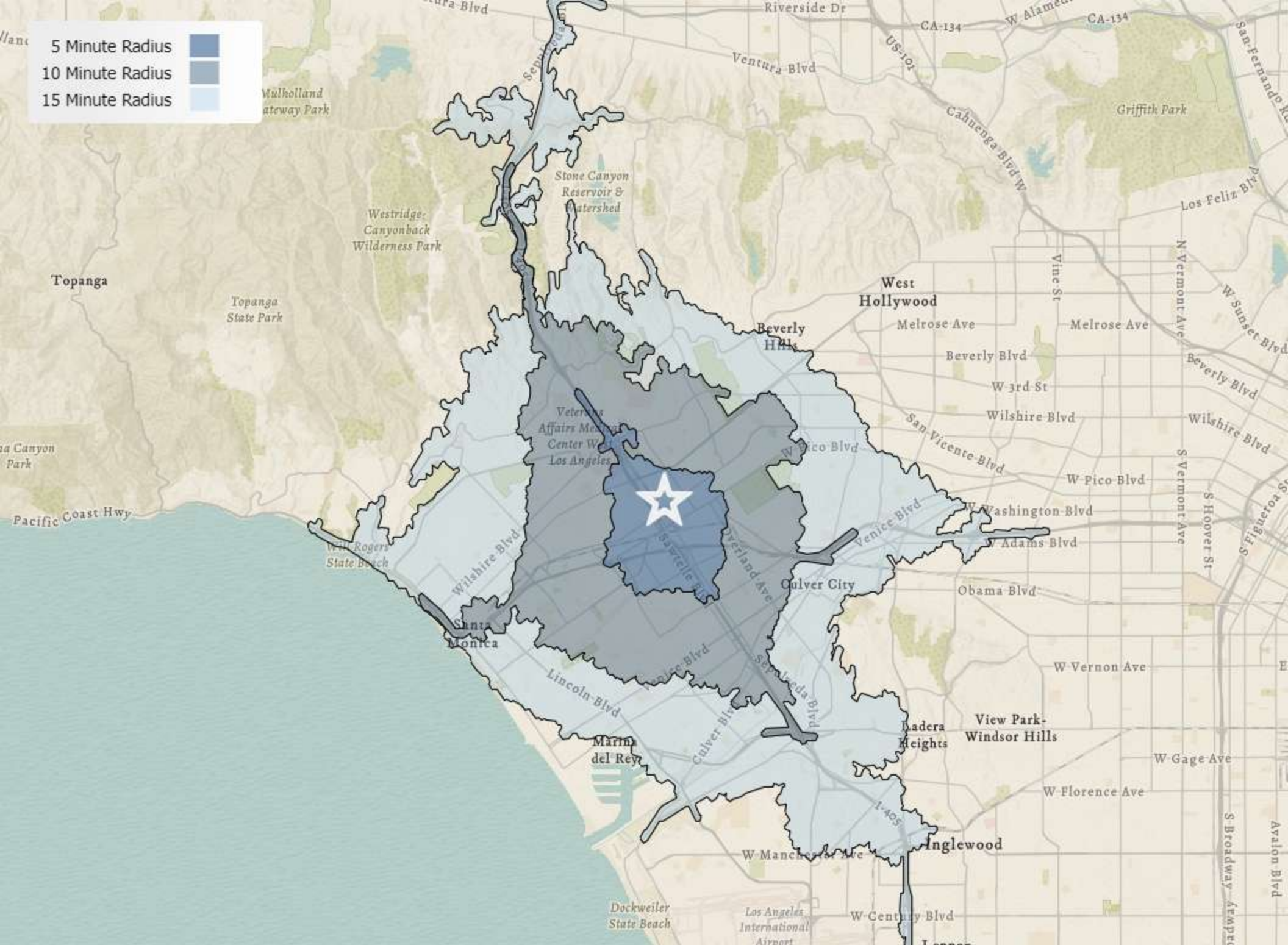



1

**UCLA**  
3.14 miles | 10.7 minutes

2

**Rodeo Drive**  
3.39 miles | 12.7 minutes

3

**Santa Monica Pier**  
5.78 miles | 14.6 minutes

4

**LAX**  
8.36 miles | 23.9 minutes

5

**Sofi Stadium**  
7.92 miles | 16.9 minutes

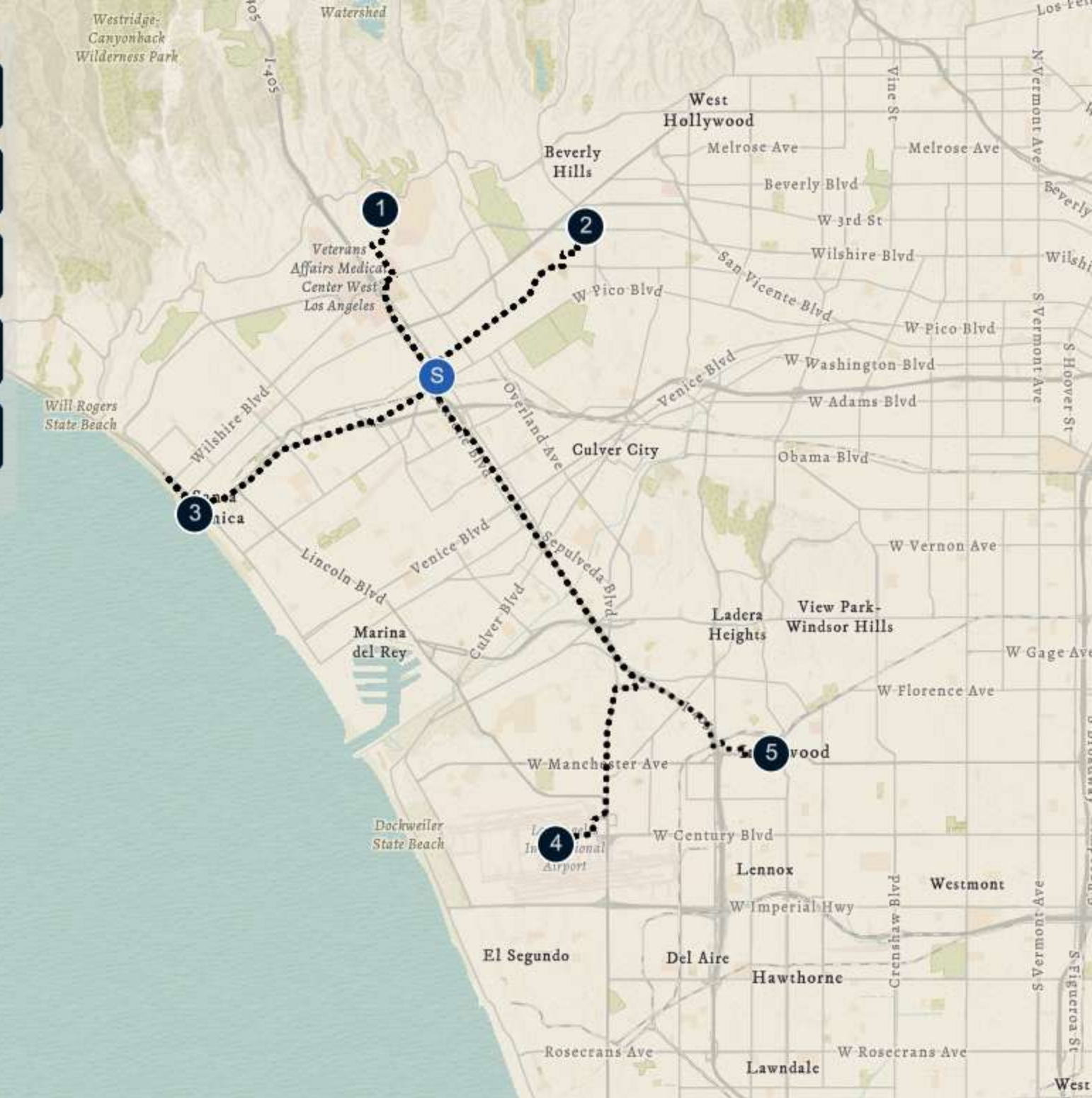



03 Property Description

- Floor Plan
- Site Plan
- Property Images

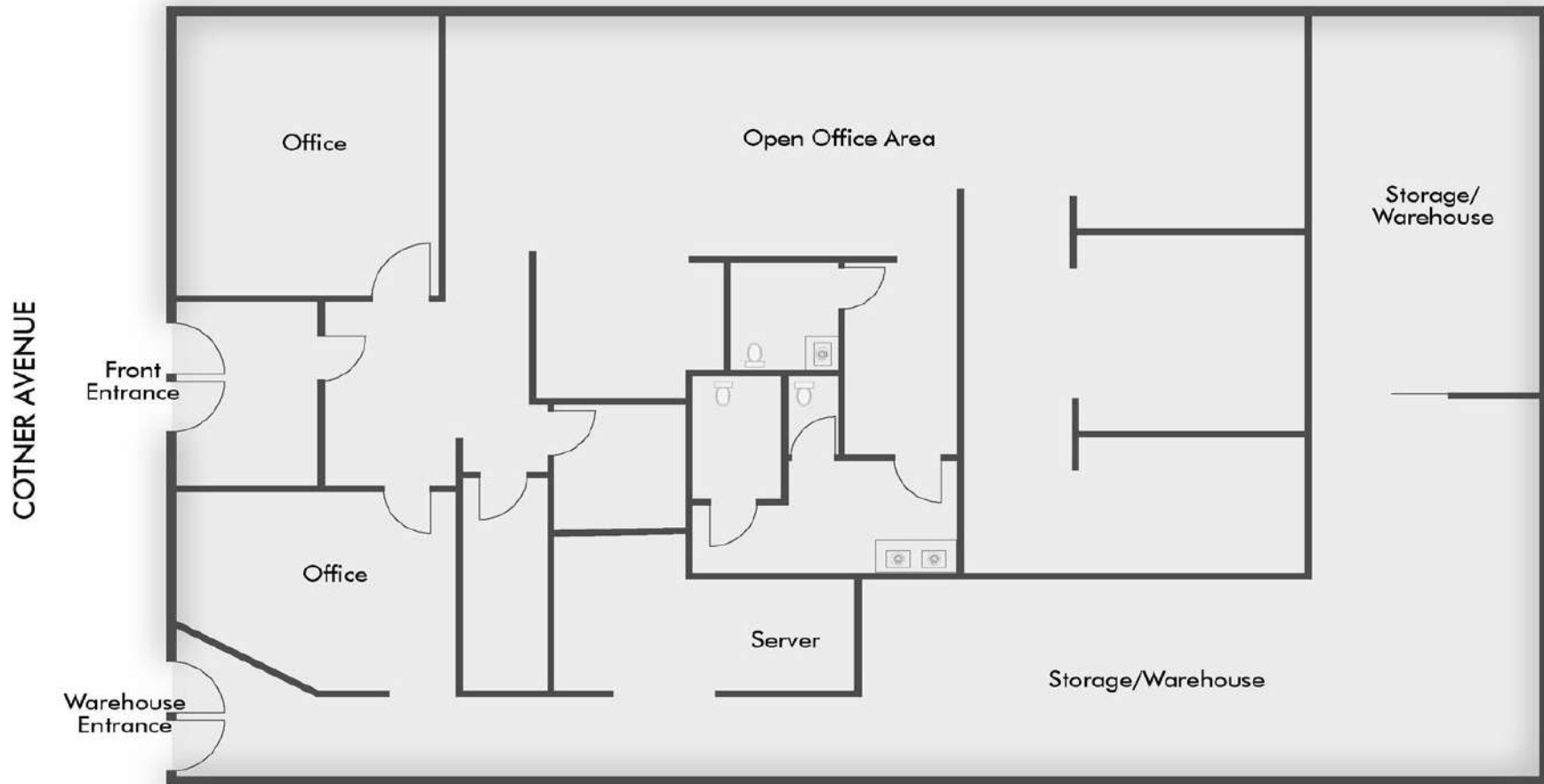

## FLOOR PLAN

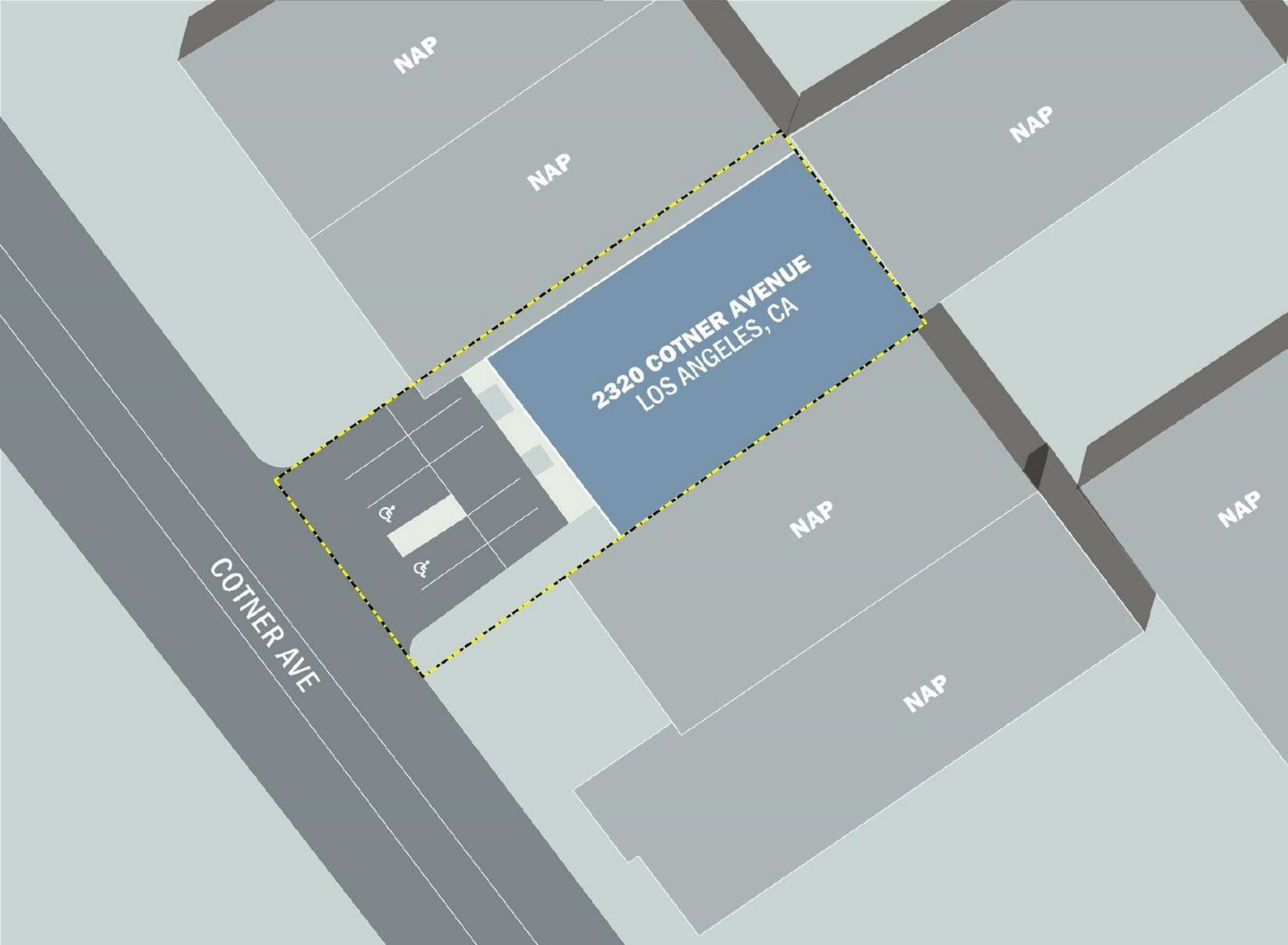

COTNER AVE

NAP

NAP

NAP

2320 COTNER AVENUE  
LOS ANGELES, CA

NAP

NAP

NAP



Lobby Area



Executive Office 1 (ground floor)



Executive Office 3 (ground floor)



Office (ground floor)





Kitchen



Executive Office 1 (2nd floor)



Executive Office 1 (2nd floor)



Open bull-pen area ground floor



Open bull-pen area ground floor



2nd Floor

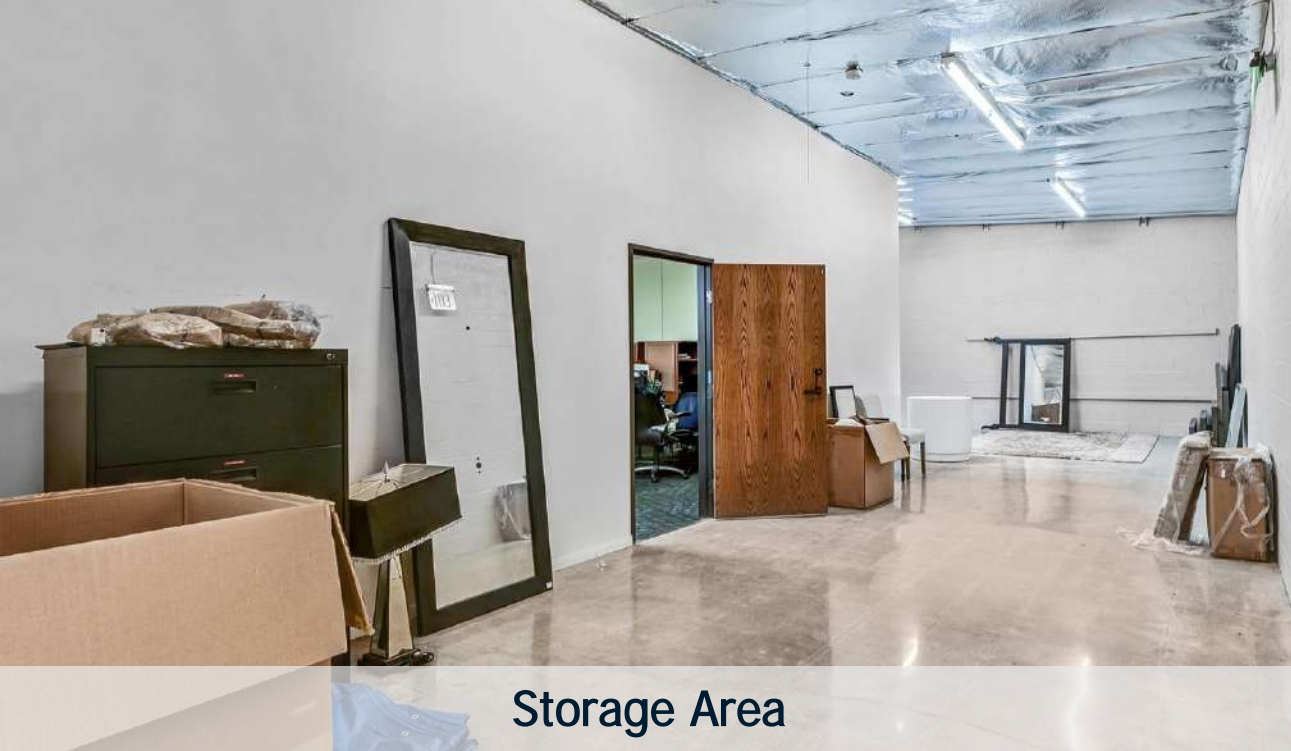

Storage Area

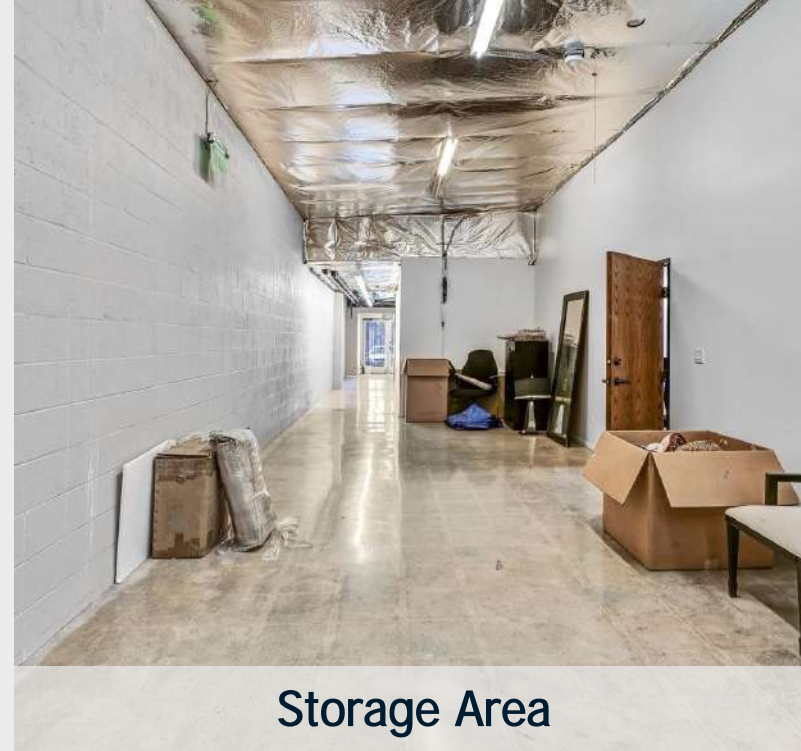

Storage Area



Warehouse



Restroom



Roof Deck



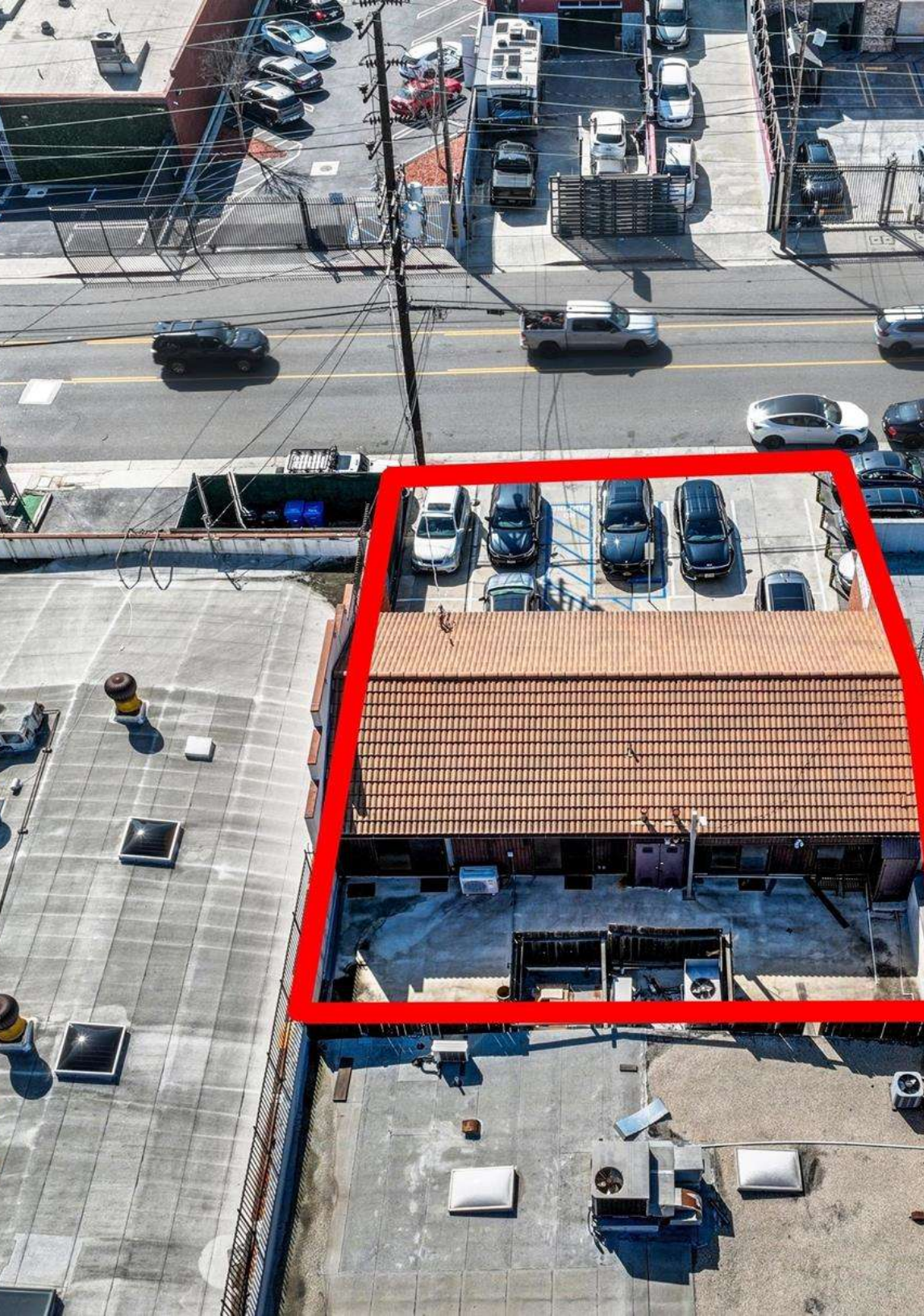

04

Demographics

Demographics

WEST L.A. OFFICE/FLEX BUILDING FOR SALE

POPULATION	1 MILE	3 MILE	5 MILE
2000 Population	31,138	303,589	602,885
2010 Population	32,424	310,808	623,084
2025 Population	35,915	323,112	648,332
2030 Population	37,038	323,651	645,817
2025-2030: Population: Growth Rate	3.10%	0.15%	-0.40%

2025 HOUSEHOLD INCOME	1 MILE	3 MILE	5 MILE
less than \$15,000	1,171	11,808	24,079
\$15,000-\$24,999	860	6,559	13,518
\$25,000-\$34,999	685	6,047	12,879
\$35,000-\$49,999	1,034	8,735	17,800
\$50,000-\$74,999	1,891	15,876	30,594
\$75,000-\$99,999	1,643	15,455	30,334
\$100,000-\$149,999	2,866	23,616	49,071
\$150,000-\$199,999	2,174	17,199	36,282
\$200,000 or greater	4,732	39,810	86,261
Median HH Income	\$117,240	\$113,135	\$117,209
Average HH Income	\$173,130	\$169,431	\$174,333

HOUSEHOLDS	1 MILE	3 MILE	5 MILE
2000 Total Housing	15,475	145,535	294,302
2010 Total Households	15,160	140,347	286,491
2025 Total Households	17,056	145,105	300,820
2030 Total Households	18,008	149,400	307,626
2025 Average Household Size	2.08	2.05	2.05
2025-2030: Households: Growth Rate	5.45%	2.95%	2.25%

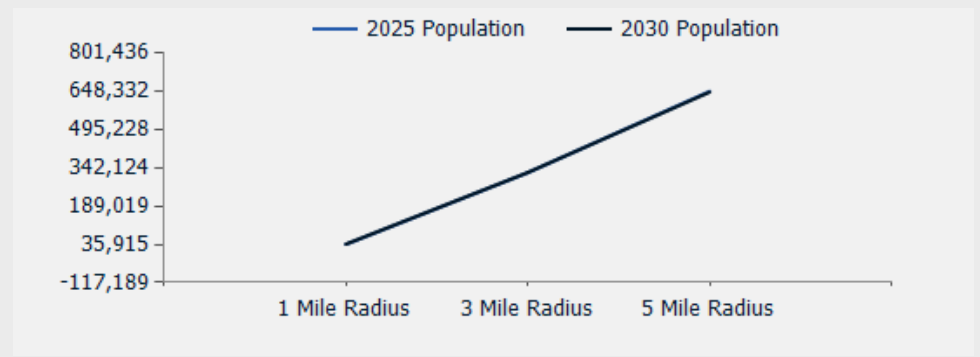

2025 Household Income

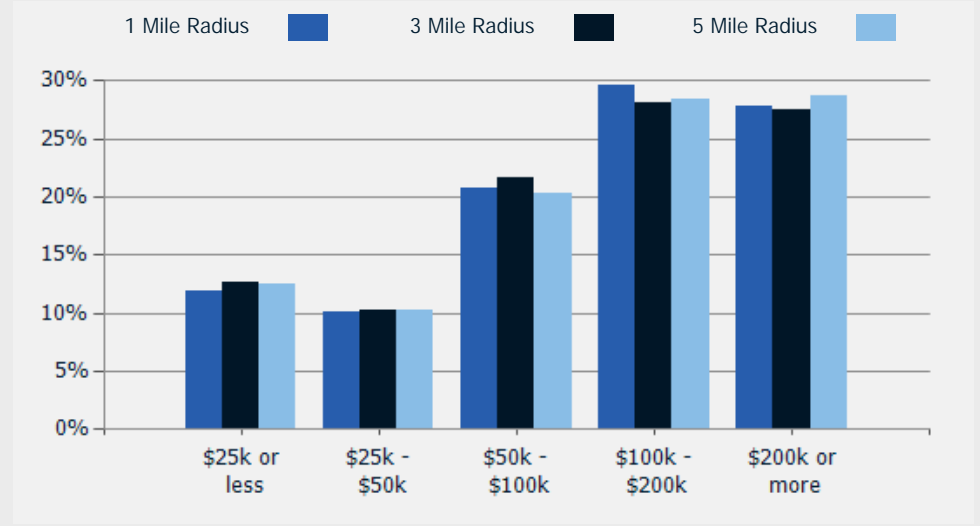

2025 Own vs. Rent - 1 Mile Radius

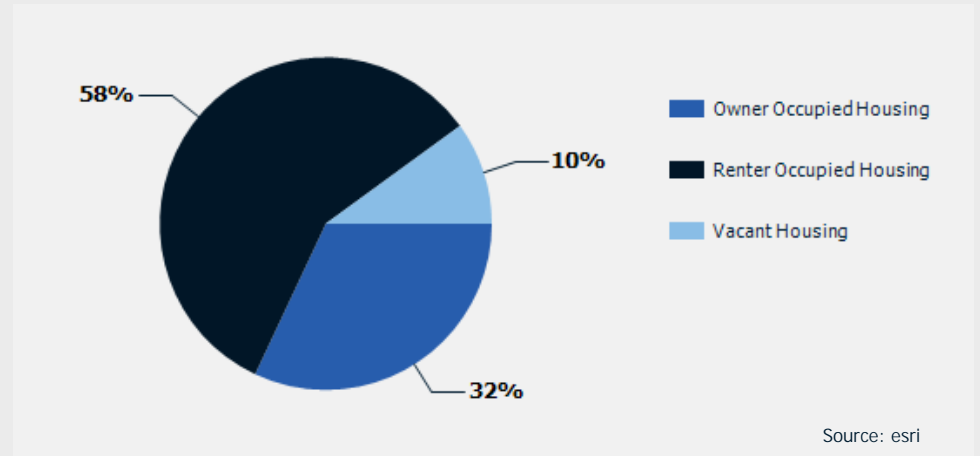

Source: esri

2025 POPULATION BY AGE	1 MILE	3 MILE	5 MILE
2025 Population Age 30-34	4,815	38,545	73,378
2025 Population Age 35-39	3,444	27,792	57,750
2025 Population Age 40-44	2,713	22,059	47,731
2025 Population Age 45-49	2,097	17,749	38,797
2025 Population Age 50-54	2,036	17,483	38,489
2025 Population Age 55-59	1,789	15,304	34,120
2025 Population Age 60-64	1,634	14,447	32,661
2025 Population Age 65-69	1,486	13,447	29,682
2025 Population Age 70-74	1,324	12,061	26,525
2025 Population Age 75-79	1,088	9,978	21,843
2025 Population Age 80-84	706	6,659	14,343
2025 Population Age 85+	754	7,816	16,571
2025 Population Age 18+	30,839	281,398	560,577
2025 Median Age	37	36	38
2030 Median Age	39	38	40

2025 INCOME BY AGE	1 MILE	3 MILE	5 MILE
Median Household Income 25-34	\$111,154	\$105,572	\$110,358
Average Household Income 25-34	\$162,059	\$151,537	\$159,677
Median Household Income 35-44	\$152,778	\$142,731	\$146,081
Average Household Income 35-44	\$202,408	\$195,795	\$198,704
Median Household Income 45-54	\$165,563	\$164,131	\$163,481
Average Household Income 45-54	\$218,800	\$217,908	\$217,977
Median Household Income 55-64	\$151,884	\$151,329	\$147,761
Average Household Income 55-64	\$199,426	\$200,775	\$199,228
Median Household Income 65-74	\$85,577	\$94,548	\$97,334
Average Household Income 65-74	\$139,850	\$153,545	\$157,161
Average Household Income 75+	\$107,873	\$121,758	\$119,406

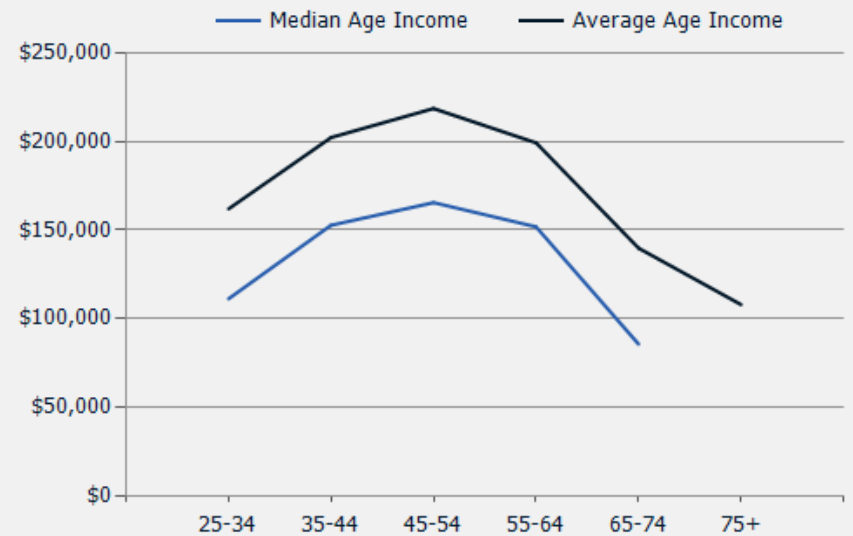
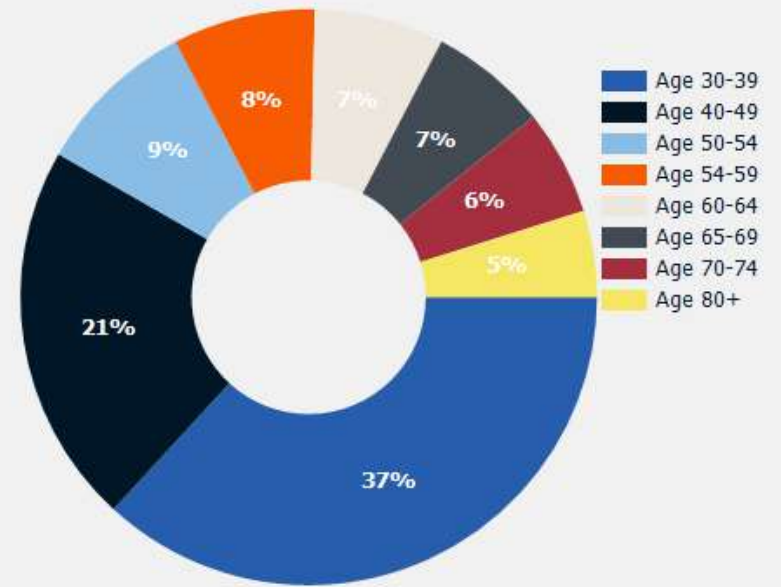

# West L.A. Office/Flex Building For Sale

## CONFIDENTIALITY and DISCLAIMER

The information contained in the following offering memorandum is proprietary and strictly confidential. It is intended to be reviewed only by the party receiving it from THE ALTEMUS COMPANY and it should not be made available to any other person or entity without the written consent of THE ALTEMUS COMPANY.

By taking possession of and reviewing the information contained herein the recipient agrees to hold and treat all such information in the strictest confidence. The recipient further agrees that recipient will not photocopy or duplicate any part of the offering memorandum. If you have no interest in the subject property, please promptly return this offering memorandum to THE ALTEMUS COMPANY. This offering memorandum has been prepared to provide summary, unverified financial and physical information to prospective purchasers, and to establish only a preliminary level of interest in the subject property.

The information contained herein is not a substitute for a thorough due diligence investigation. THE ALTEMUS COMPANY has not made any investigation, and makes no warranty or representation with respect to the income or expenses for the subject property, the future projected financial performance of the property, the size and square footage of the property and improvements, the presence or absence of contaminating substances, PCBs or asbestos, the compliance with local, state and federal regulations, the physical condition of the improvements thereon, or financial condition or business prospects of any tenant, or any tenant's plans or intentions to continue its occupancy of the subject property.

The information contained in this offering memorandum has been obtained from sources we believe reliable; however, THE ALTEMUS COMPANY has not verified, and will not verify, any of the information contained herein, nor has THE ALTEMUS COMPANY conducted any investigation regarding these matters and makes no warranty or representation whatsoever regarding the accuracy or completeness of the information provided. All potential buyers must take appropriate measures to verify all of the information set forth herein. Prospective buyers shall be responsible for their costs and expenses of investigating the subject property.

*Exclusively Marketed by:*

**JUSTIN ALTEMUS**  
THE ALTEMUS COMPANY  
The Altemus Company  
(310) 478-7729  
JUSTIN@ALTEMUSCOMPANY.COM  
Lic: 01271444